

IDEAL[®]

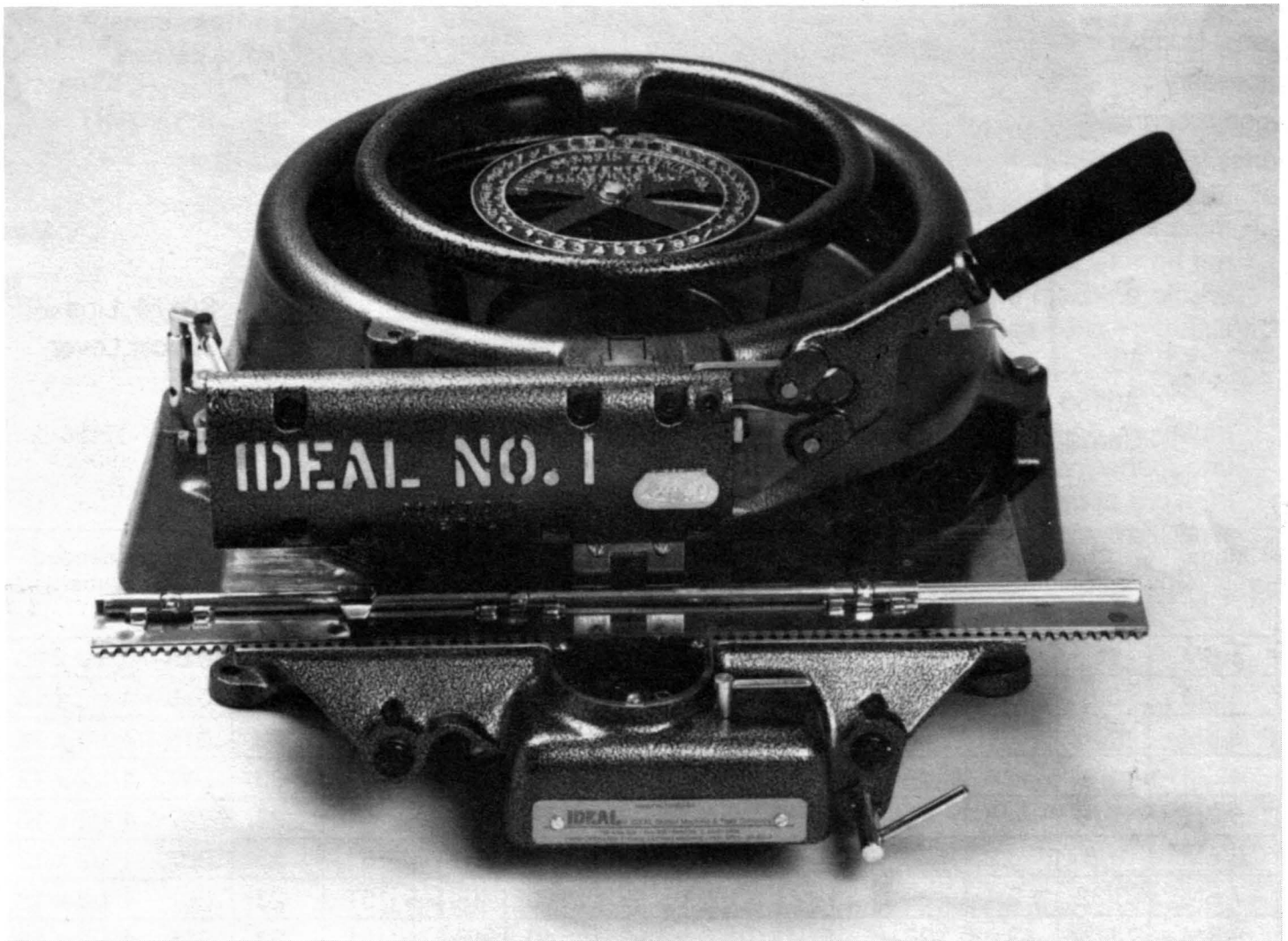

STENCIL CUTTING MACHINES "IDE-TAG"[®] EMBOSSING MACHINES



OPERATING AND MAINTENANCE MANUAL PARTS CATALOG

IDEAL Stencil Machine & Tape Company

102 Iowa Ave. • Box 305 • Belleville, IL 62222-0305 • Phone (618) 233-0162 • FAX (618) 233-5091

A0132 Dial (in newer machines the dial is flat and does not use gears. For die carrier and pointer gears on older models, see part # S0134 and S0149)

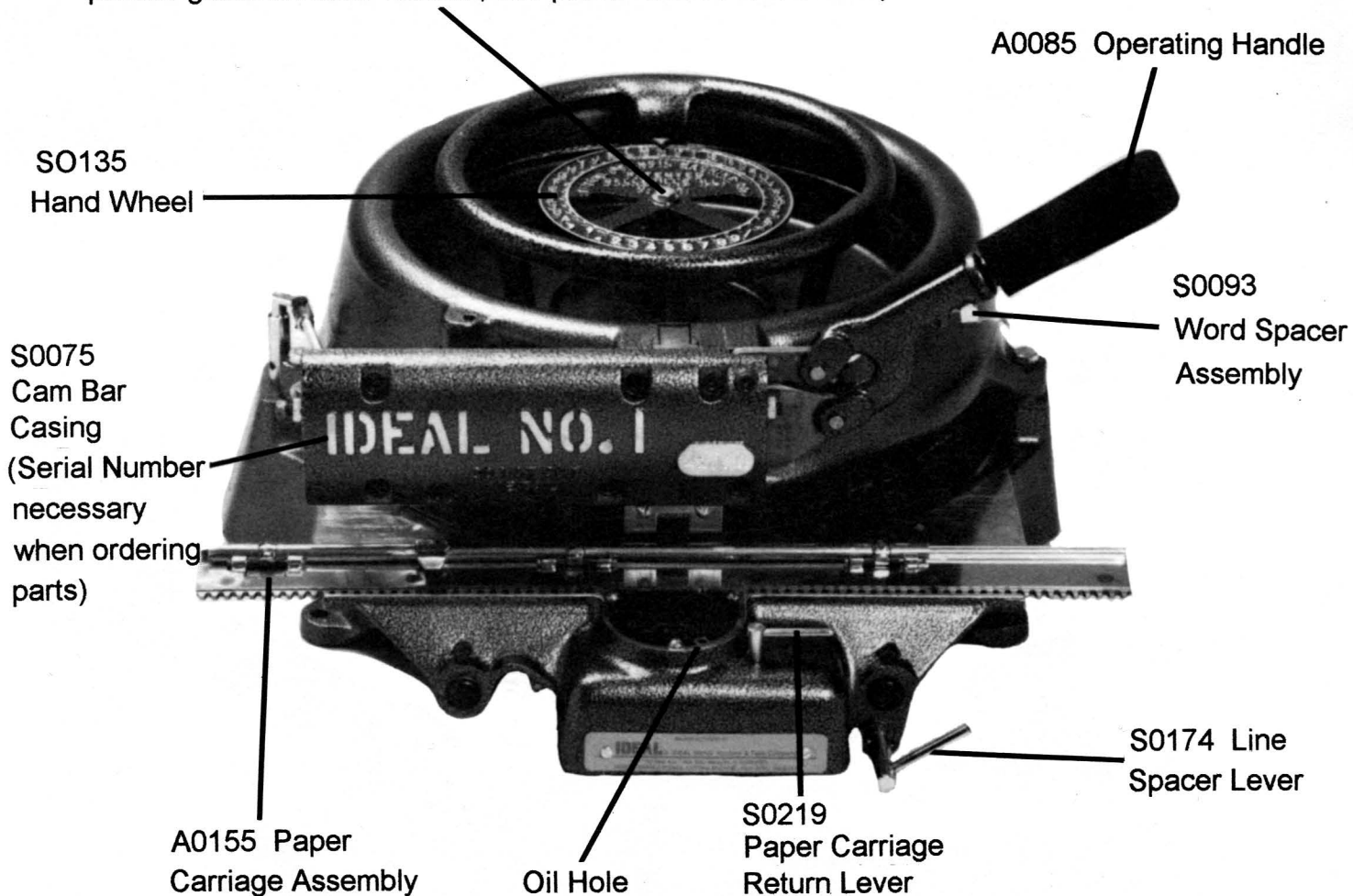

Model	Character Height		Char. per Foot	No. of Lines	Total Height for No. of Lines		Net Weight		Shipping Weight		Recommended Stencilboard Size	
1 SM	1	25.4	14	4	5 1/4	133	69	31.3	85	38	.015	6 1/2 x 20
2 SM	5/8	15.9	19	4	3 1/2	89	40	18.1	51	23	.015	4 1/2 x 16
3 SM	7/16	11.1	26	5	3 1/4	83	40	18.1	51	23	.015	4 1/2 x 16
4 SM	1/4	6.4	46	10	3 1/4	83	40	18.1	51	23	.007	4 1/2 x 12
5 SM	3/16	4.8	48	10	3 1/4	83	40	18.1	51	23	.007	4 1/2 x 12
6 SM	1/8	3.2	75	13	3 1/4	83	40	18.1	51	23	.007	4 1/2 x 12
7 SM	3/32	2.4	89	13	3 1/4	83	40	18.1	51	23	.007	4 1/2 x 12
8 SM	1/2	13.0	26	5	3 1/4	83	40	18.1	51	23	.015	4 1/2 x 16
9 SM	3/4	19.0	19	4	3 1/2	89	40	18.1	51	23	.015	4 1/2 x 16
Russian	1	25.4	14	4	5 1/4	133	69	31.3	85	38	.015	6 1/2 x 20
Russian	5/8	15.9	19	4	3 1/2	89	40	18.1	51	23	.015	4 1/2 x 16
Russian	7/16	11.1	26	5	3 1/4	83	40	18.1	51	23	.015	4 1/2 x 16

Competitive Exchange, trade-in, repair programs available

THANK YOU for purchasing an Ideal Stencil Cutting Machine or Embossing Machine. At Ideal, manufacturing high quality marking equipment and supplies is our business. We are dedicated to provide the highest level of service and support to our customers. If you have any suggestions, please let us know: call 1-800-388-0162, or write us at P.O. Box 305, Belleville, IL 62222-0305. We value your opinion.

OPERATING INSTRUCTIONS FOR IDEAL STENCIL AND EMBOSSING MACHINES

Please read carefully before using. It may take you a few minutes, but you will be rewarded with years of trouble-free use.

UNPACKING: Carefully unpack your machine. **Do not lift the machine by the paper carriage or by the handle as they might bend.** Grab the machine from the handwheel and place it on a workbench. To avoid back injuries, we recommend two people perform this operation. The machine is bolted to a plywood base. Loosen and take off the three nuts located on the machine feet and lift the machine off the plywood base. We suggest you keep all original packing materials in case you need to ship the machine.

INSTALLATION: Place machine securely on a workbench. To add stability, you might want to bolt it down. Remove the tape around the handwheel and the operating handle. Make sure you have enough room to the right and left of the machine (approx. 18" on each side). Turn the Paper Carriage Return Lever (part # S0219) and the paper carriage will move to the right. **CAUTION!:** Keep fingers away from carriage!

OPERATION: ***Handwheel/Operating Handle:*** Stand in front of the machine. Place your left hand on the handwheel and rotate it left or right until the pointer indicates the character you want. While your left hand is still on the handwheel, grasp the operating handle with your right. Push it down: the character selected will be cut and the paper carriage will be ready for the next cut. To space between characters pull the trigger underneath the handle with your index finger (part # S0093 - Word Spacer Assembly), and **GENTLY** push the handle halfway down. **Do not force the handle all the way down when spacing, because this will break the word spacer.**

Line Spacer Lever (Part # S0174): On the bottom right hand side of your machine you will see the line spacer lever, which is used to change lines on your stencil by moving the machine's table. While holding the handwheel (at 6 o'clock) with your left hand, hold the line spacer lever with your right hand, rotate it to the right, pull the table towards you until it stops, then rotate the lever left to its original position. Try this a few times. Notice that once the table is all the way out, you can just flick the lever to the right with your index finger, and the line spacer will move in one line (you may also rotate the lever to the right, reach the line you need, and return the lever to the left). Note: on models 4, 5, 6 and 7 there is a line indicator above the right foot of the machine.

Paper Carriage Return Lever (Part # S0219): This lever controls the paper carriage spring. Rotate it to move the paper carriage to the right, whenever you need to start cutting a new line.

CAUTION! Do not keep your left hand or fingers inside the paper carriage while flicking the paper carriage lever with your right hand.

Loading the Stencilboard: Pull the table all the way out using the line spacer lever. Take a sheet of stencilboard of the appropriate paper size (see chart on page 2 for details). Load from the right hand side of the machine, at an angle, until the sheet is even with the left edge of the paper carriage. Press the thumb bar to lift the gripper bar. Insert the stencilboard. Make sure the carriage is all the way to the right by pulling the Paper-Carriage Return Lever (part # S0219). The stencilboard should move freely.

CUT A STENCIL: Your oilboard is now loaded and your paper carriage is all the way to the right. Make sure your Line Spacer (part # S0174) is out all the way, and that you are starting to cut from the upper left hand corner of your stencilboard. Select the desired letter on the dial. Push the operating handle all the way down. When the first line is completed, flick the paper carriage lever and the line spacer lever, and you will be ready for the next line. Remember, when spacing between words, just grab the line spacer trigger located underneath the handle with your index finger while depressing the handle gently half way down (do not force the handle down while holding the word spacer!).

FOR BEST RESULTS, USE ORIGINAL IDEAL STENCILBOARD AND INKS!

RECOMMENDED STENCIL AND EMBOSSING MATERIALS:

Stencil machines with **normal** punches and dies are designed to cut **.015 Oiled Stencilboard** (machine sizes 1/4" and larger) and **.007 Oiled Stencilboard** (3/16" and smaller); they may also cut **ULTRA-CUT®**, a new polyethylene stencil material with removable adhesive backing. Stencil machines with special **hardened** punches and dies may cut up to .004" polyester materials (such a **POLY-EXTRA II**, a new polyester stencil material with removable adhesive backing) and magnetic rubber materials. **Do not cut metals** with stencil machines, as the punches and dies will become dull or broken.

Embossing machines are designed to emboss **aluminum or other soft metal tags up to .010" thick**. They are not designed to emboss thicker metals or stainless steel.

FOR MORE INFORMATION ON VARIOUS STENCIL AND EMBOSSING MATERIALS AVAILABLE, OR FOR TESTING OF ANY SPECIAL MATERIAL YOU MAY WANT TO USE, PLEASE DO NOT HESITATE TO CONTACT IDEAL'S CUSTOMER SERVICE AT 618-233-0162 OR FAX 618-233-5091.

MAINTENANCE

Ideal stencil and embossing machines are built to provide years of maintenance free operation. Monthly, clean the stencil machine's punches from oilboard cuttings which may be trapped inside characters, by using the **cleaning hook** provided with each machine. A pocket mirror placed beneath each punch will help you see the punch was cleaned properly.

Periodically, pour a few drops of a good lubricant in the oilhole provided in the front of the machine.

Keep your machine covered when not in use. **For best results use only original Ideal stencilboard.**

SPACING ADJUSTMENTS

The following causes may affect spacing between characters:

1. To adjust, loosen the locknut on part # S0109 Lock Assembly, grip the end of the screw and turn it counter clockwise, approximately one half turn or until excess play is removed from lock. Retighten locknut once adjustment is made.
2. Make sure that part # S0128 Rod for Feed Lever, is not bent. If it is bent, replace it, making sure it moves freely.
3. Check underneath the machine, part # A0065, Compensating Rod, and make sure it moves freely, it might need replacement or adjusting.

Should these procedures not yield proper results, we recommend you return the machine to Ideal for repairs.

PUNCH DEPTH ADJUSTMENT

To adjust the Cam Bar Casing depth of the punch penetration into the die, adjust the lock screw on the left side of the bar casing (part # S0075). Turning it clockwise raises the punch; counterclockwise lowers it. Proper punch depth can be assured by using a piece of .015 stencilboard. Select the letter "I" and place a corner of the stencilboard on the edge of the die (but not over the hollow character part). Depress the handle, so that the punch snugly pinches the .015 board. This operation will ensure proper clearance between punch and die.

REPLACEMENT OF PUNCHES AND DIES

Note: punches and dies for machine models 5, 6 and 7 are very small and may be damaged when not installed properly. We strongly recommend to have them replaced at our plant.

Punches and dies must be replaced as a complete unit.

All dies have one cutting side only and they must be mounted on the die carrier with the cutting side facing the punch; to avoid confusion, before prying a new die apart from the punch, mark the cutting side with a felt tip marker.

Disconnect the Feed Rod (part # S0128) on the left side of the machine by removing the pins. Remove the Hand Wheel by taking out the three screws. Remove Stripper (part # S0036) by taking out screws. Remove the Hood. The punches and dies are now exposed. Remove the die by taking out the die screws from the bottom of the machine. Release the punch guide screw and press the punch downward with a screw driver.

Care must be taken to avoid damage to the cutting edge of the punch. The die must be removed from the punch before inserting it.

Replace the punch through the bottom of the machine by installing the punch spring and the punch guide at the same time, thru the die carrier and into the punch carrier. Tighten the punch screws (not all the way).

Carefully place the die on the die carrier, then push the punch down until it rests on the die. Make sure it is aligned properly.

Insert the die screws slowly, before tightening them, pull the punch back up to the cutting edge and then tighten the die screws. Now the punch and die should be lined up properly with the adjacent dies. Tighten the punch screws. Test a few times and make sure the punch is aligned with adjacent punches.

Reassemble hood, stripper, hand wheel, and rod for feed lever, in this order.

PARTS LIST

IMPORTANT: when ordering parts, please provide model and serial number of your machine (both may be found on the CAM-BAR casing, part # S0075).

Stock No.	Part Name
-A0030	Base
-C0032	Center Spindle
-S0035	Bracket for Dial w/2 Screws (Angled Dial Models Only)
-S0036	Stripper w/Screws (4 for 1SM; 2 for Other Models)
-S0040	Retaining Bracket for Die Carrier w/2 Screws
-S0041	Impact Plate w/2 Screws
-S0061	Bracket for Feedshaft w/2 Screws
-S0062	Feedshaft Rocker w/1 Screw & 1 Key
-A0065	Compensating Rod Assembly w/Rivet
-A0044	Vertical Shaft Assembly

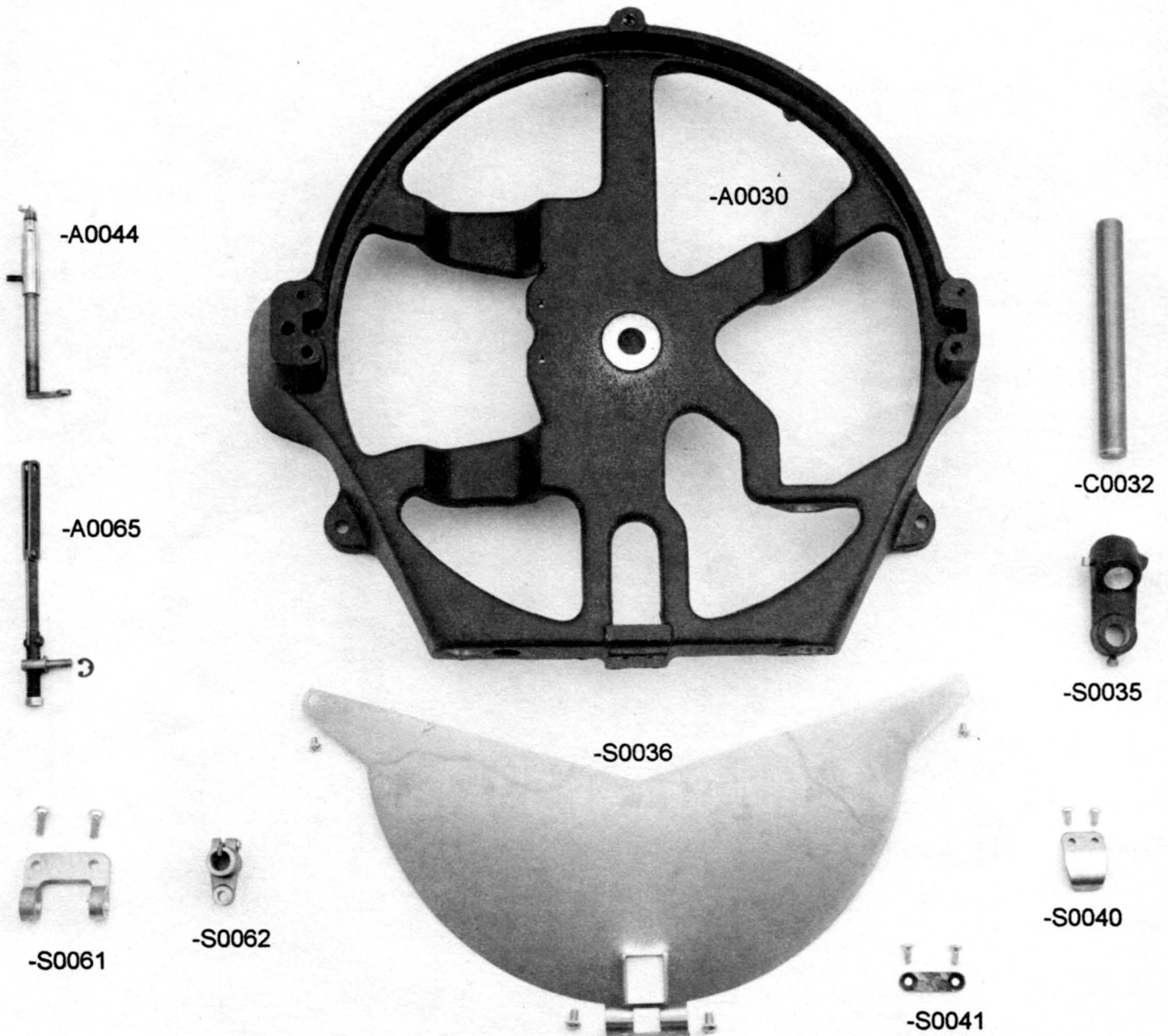

Stock No. Part Name

- P0198 Spring for Operating Pawl
- S0190 Operating Pawl Plate Assembly w/Screw & Nut
- P0202 Spring for Operating Pawl Plate
- A0205 Retaining Pawl Plate Assembly
- P0202 Spring for Retaining Pawl Plate
- S0196 Adjusting Screw for Retaining Pawl Plate w/Nut
- A0209 Locking Pawl Assembly
- P0213 Spring for Locking Pawl
- A0214 Pawl Release Plate Assembly
- S0219 Paper Carriage Return Lever w/2 Washers and Nuts
- S0225 Carriage Rack & Pinion Gear Assembly w/Washer, 2 Screws & Ratchet Wheel
- P0234 Spring for Pinion Spindle
- S0236 Upper Cover Plate w/3 Screws & Decal

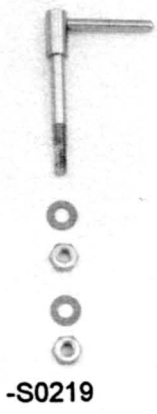
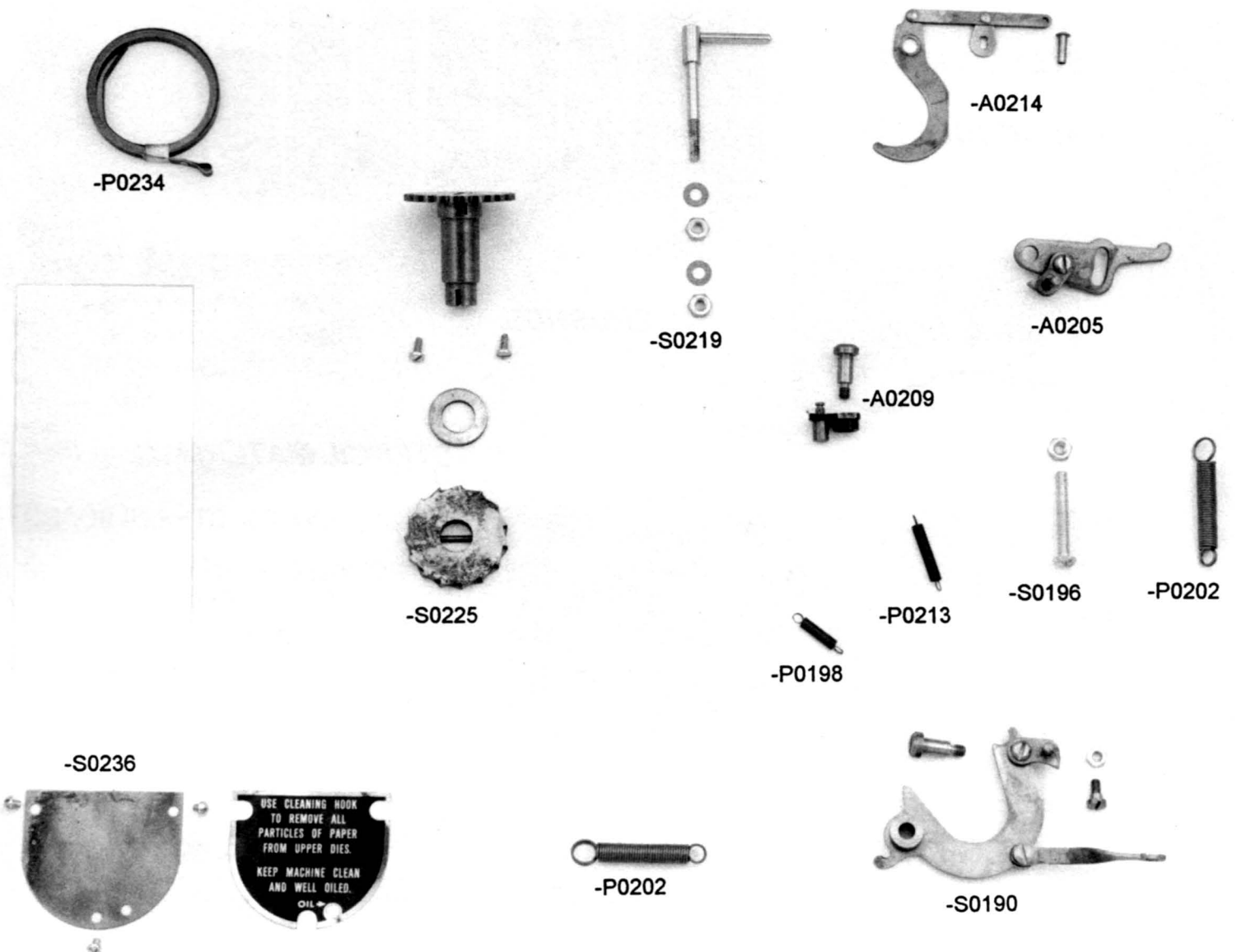

USE CLEANING HOOK
TO REMOVE ALL
PARTICLES OF PAPER
FROM UPPER DIES.
KEEP MACHINE CLEAN
AND WELL OILED.
OIL

Stock No. Part Name

- S0055 Hood w/3 Screws
- S0075 Cam Bar Casing w/7 Screws & 2 Nuts
- A0081 Cam Bar Assembly
- P0084 Spring for Cam Bar
- A0085 Operating Handle
- S0088 2 Pins & 4 Snap Rings for Operating Handle
- S0089 Handle Link w/Screw
- S0093 Word Spacer Assembly w/Screw & Spring
- S0101 Plunger w/Roller
- S0250 Line Indicator w/2 Screws (For use ONLY for #4, 5, 6 & 7)

Stock No. Part Name

- S0109 Lock Assembly w/Screw, Spring & Nut
- S0117 Rocker for Lock w/Screw & Roller
- S0120 Bracket for Rocker w/2 Screws
- S0121 Feed Lever Assembly w/Roller
- P0092 Short Screw for Feed Lever
- P0127 Long Screw for Feed Lever
- S0128 Rod for Feed Lever Assembly w/Pin & Snap Rings
- A0132 Dial
- A0133 Pointer
- S0134 Gear for Pointer w/1 Screw (S/N 32631 or Higher)
- OG134 Gear for Pointer w/1 Screw (For 1SM S/N 32630 or Lower)

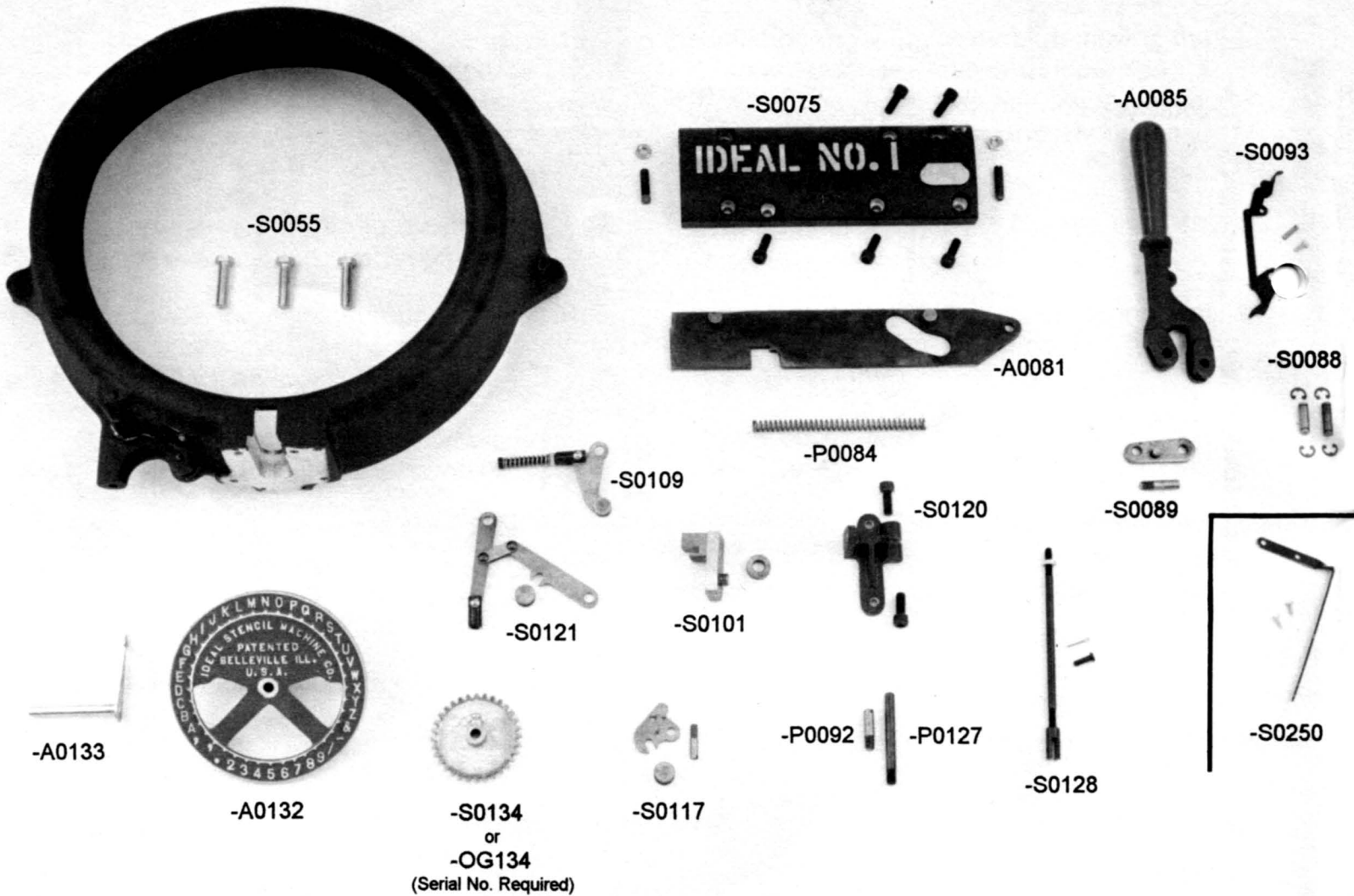

Stock No. Part Name

- S0135 Hand Wheel w/3 Screws
- S0137 Punch Carrier w/4 Screws
- S0138 Punch & Die Set Assembly (Guide, Spring, 2 Die Screws, 1 Punch Guide Screw)
- A0147 Die Carrier
- S0148 Die Carrier Gear w/2 Screws (S/N 32631 or Higher)
- S0149 Die Carrier Gear w/2 Screws (for 1SM S/N 32630 or Lower)

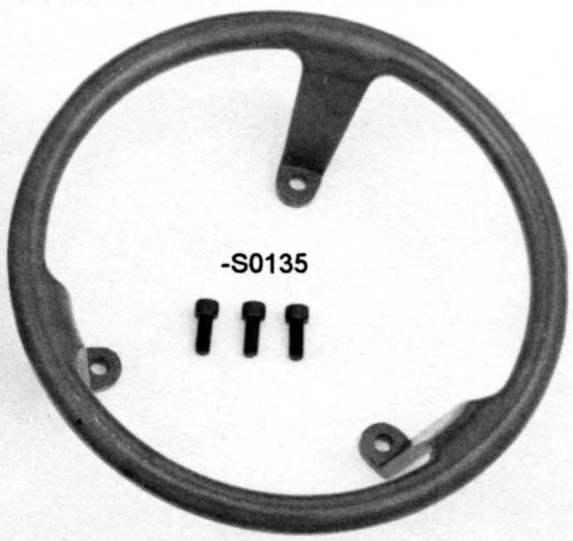
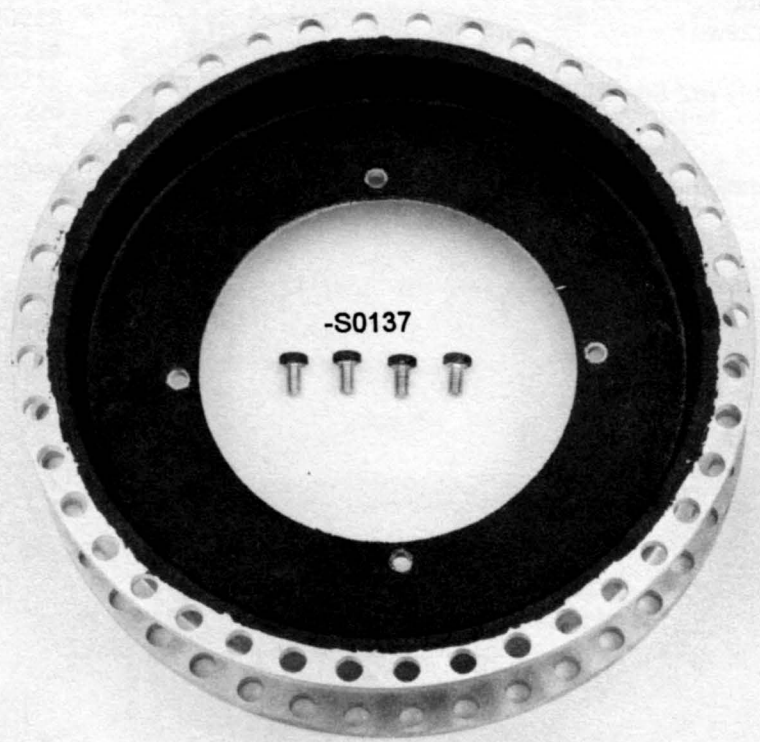

-S0148
or
-S0149
(Serial No. Required)

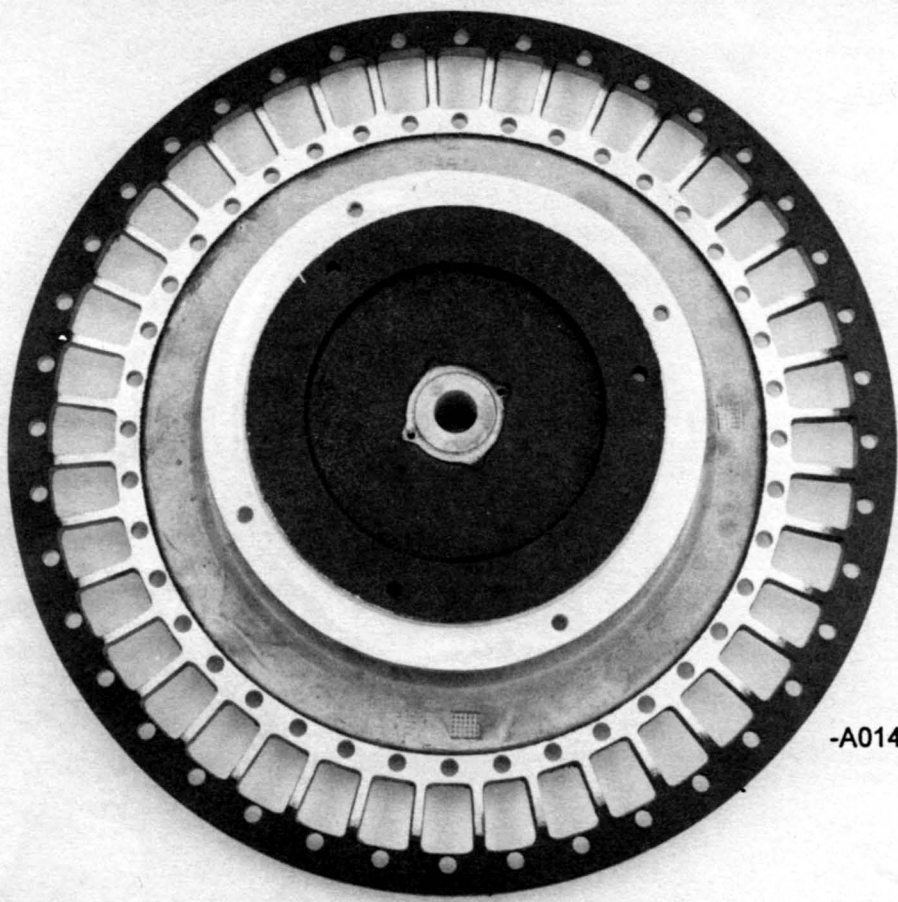

-S0138

Stock No. Part Name

- S0151 Table & Wings Assembly
- S0150 Table & Wings Complete w/Parts from S0151 thru C0236*
- A0155 Paper Carriage Assembly w/3 Springs and Gripper
- S0168 Long Table Slide Assembly w/Spring, Pin, and Plug
- S0173 Short Table Slide w/Plug
- S0174 Line Spacer Shaft w/Collar and Nut
- S0181 Spring for Line Spacer Shaft w/Screw
- S0182 Line Spacer Rack w/2 Screws
- S0184 Carriage Bumper Bracket Assembly w/2 Screws
- A0057 Feed Shaft and Cotter Key

*Part S0150 is a complete assembly of all stencil machine table parts ready for installation

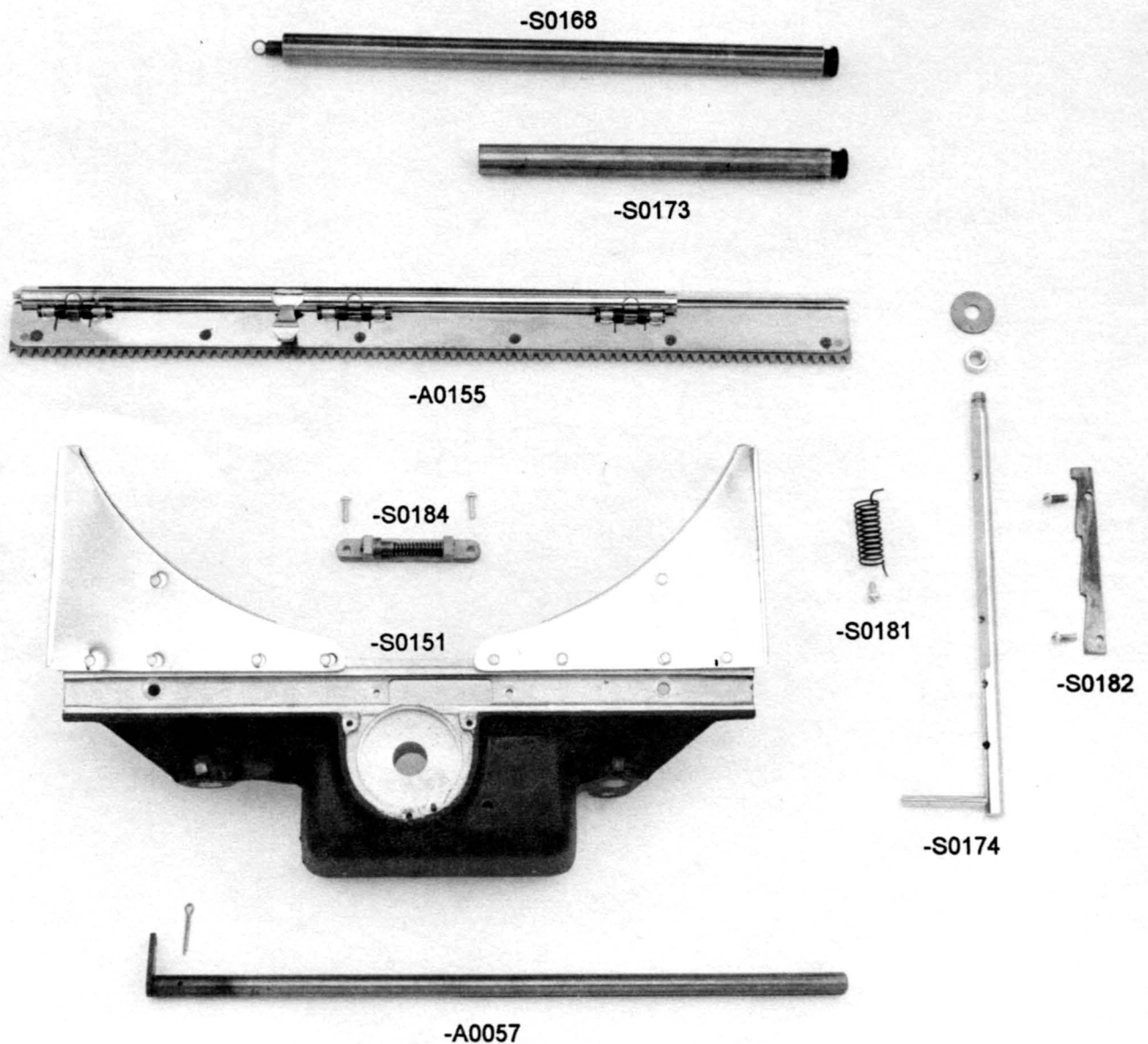

IDEAL®

HIGH QUALITY MARKING
EQUIPMENT AND SUPPLIES
SINCE 1911:

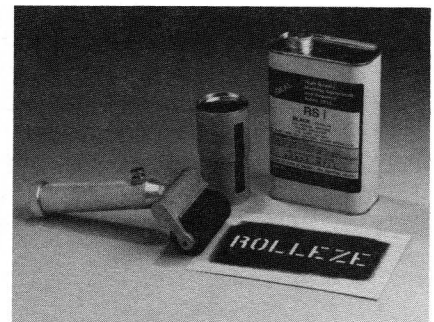

THE WIDEST RANGE OF STENCIL ROLLERS,

**STENCIL INKS,
AEROSOL INKS,**



BRUSHES,

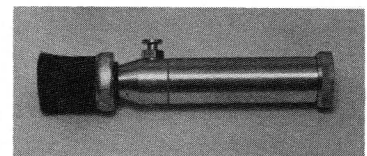

STENCIL MATERIALS:

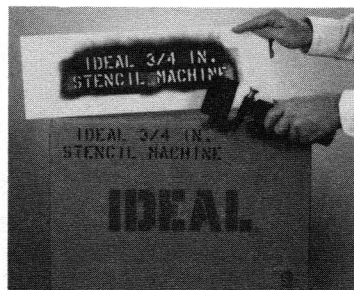
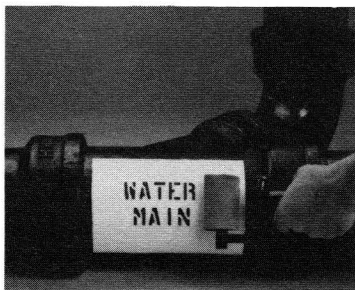

- 015 AND .007 STENCILBOARD
- POLY-EXTRA II™ (A NEW ADHESIVE BACKED POLYESTER MATERIAL)
- ULTRA-CUT® (POLYETHYLENE STENCIL MASK)
- MAGNETIC VINYL, AND MORE

FOR A COMPLETE CATALOG OR COMPETITIVE QUOTATION,
CONTACT YOUR LOCAL IDEAL DISTRIBUTOR OR CALL
1-800-388-0162 (FAX 618-233-5091).